



# K7 Server Manual

**Document Version 2.0**

**Feb. 2023**

© Copyright BITMAIN 2007 – 2022. All rights reserved.

BITMAIN reserves the right to make corrections, modifications, enhancements, improvements, and other changes to its products and services at any time and to discontinue any product or service without notice.

Customers should obtain the latest relevant information before placing orders and should verify that such information is current and complete. All products are sold subject to BITMAIN's terms and conditions of sale supplied at the time of order acknowledgment.

BITMAIN warrants performance of its products to the specifications applicable at the time of sale in accordance with BITMAIN's standard warranty. Testing and other quality control techniques are used to the extent BITMAIN deems necessary to support this warranty. Except where mandated by government requirements, testing of all parameters of each product is not necessarily performed.

BITMAIN assumes no liability for third-party applications assistance. Customers are responsible for their products and applications using BITMAIN components. To minimize the risks associated with customer products and applications, customers should provide adequate design and operating safeguards.

BITMAIN does not warrant or represent that any license, either express or implied, is granted under any BITMAIN patent right, copyright or other BITMAIN intellectual property right relating to any combination, machine, or process in which BITMAIN products or services are used. Information published by BITMAIN regarding third-party products or services does not constitute a license from BITMAIN to use such products or services or a warranty or endorsement thereof. Use of such information may require a license from a third party under the patents or other intellectual property of the third party, or a license from BITMAIN under the patents or other intellectual property of BITMAIN.

Resale of BITMAIN products or services with statements different from or beyond the parameters stated by BITMAIN for that product or service voids all express and any implied warranties for the associated BITMAIN product or service and is an unfair and deceptive business practice. BITMAIN is not responsible or liable for any such statements.

All company and brand products and service names are trademarks or registered trademarks of their respective holders.

All text and figures included in this publication are the exclusive property of BITMAIN, and may not be copied, reproduced, or used in any way without the express written permission of BITMAIN. Information in this document is subject to change without notice and does not represent a commitment on the part of BITMAIN. Although the information in this document has been carefully reviewed, BITMAIN does not warrant it to be free of errors or omissions. BITMAIN reserves the right to make corrections, updates, revisions or changes to the information in this document.

BITMAIN

Tel: +86-400-890-8855

[www.BITMAIN.com](http://www.BITMAIN.com)

## Table of Contents

<b>1. Overview</b> .....	<b>4</b>
1.1 K7 Server Components .....	5
1.2 Specifications.....	7
<b>2. Setting up the Server</b> .....	<b>10</b>
<b>3. Configuring the Server</b> .....	<b>13</b>
<b>4. Monitoring Your Server</b> .....	<b>14</b>
<b>5. Administering Your Server</b> .....	<b>15</b>
5.1 Checking Your Firmware Version .....	15
5.2 Upgrading Your System .....	15
5.3 Modifying Your Password.....	16
5.4 Restoring Initial Settings.....	16
<b>Environmental Requirements</b> .....	<b>17</b>
<b>Regulations:</b> .....	<b>19</b>

## 1. Overview

The K7 server is BITMAIN's newest version in this series. Power supply APW12 is part of K7 server. All K7 servers are tested and configured prior to shipping to ensure easy set up.



**Front View**



**Back View**



**Caution:**

1. Please refer to the layout above to place your goods in usage in case of any damage.
2. The equipment must be connected to an earthed mains socket-outlet. The socket-outlet shall be installed near the equipment and shall be easily accessible.
3. The equipment has two power inputs. Only by connecting those two power supply sockets simultaneously can the equipment run normally. When the equipment is powered off, be sure to power off all power inputs.
4. DO NOT remove any screws and cables tied on the product.
5. DO NOT PRESS the metal button on the cover.
6. Please note that the actual server shall prevail.

## 1.1 K7 Server Components

The main components and controller front panel of K7 servers are shown in the following figure:

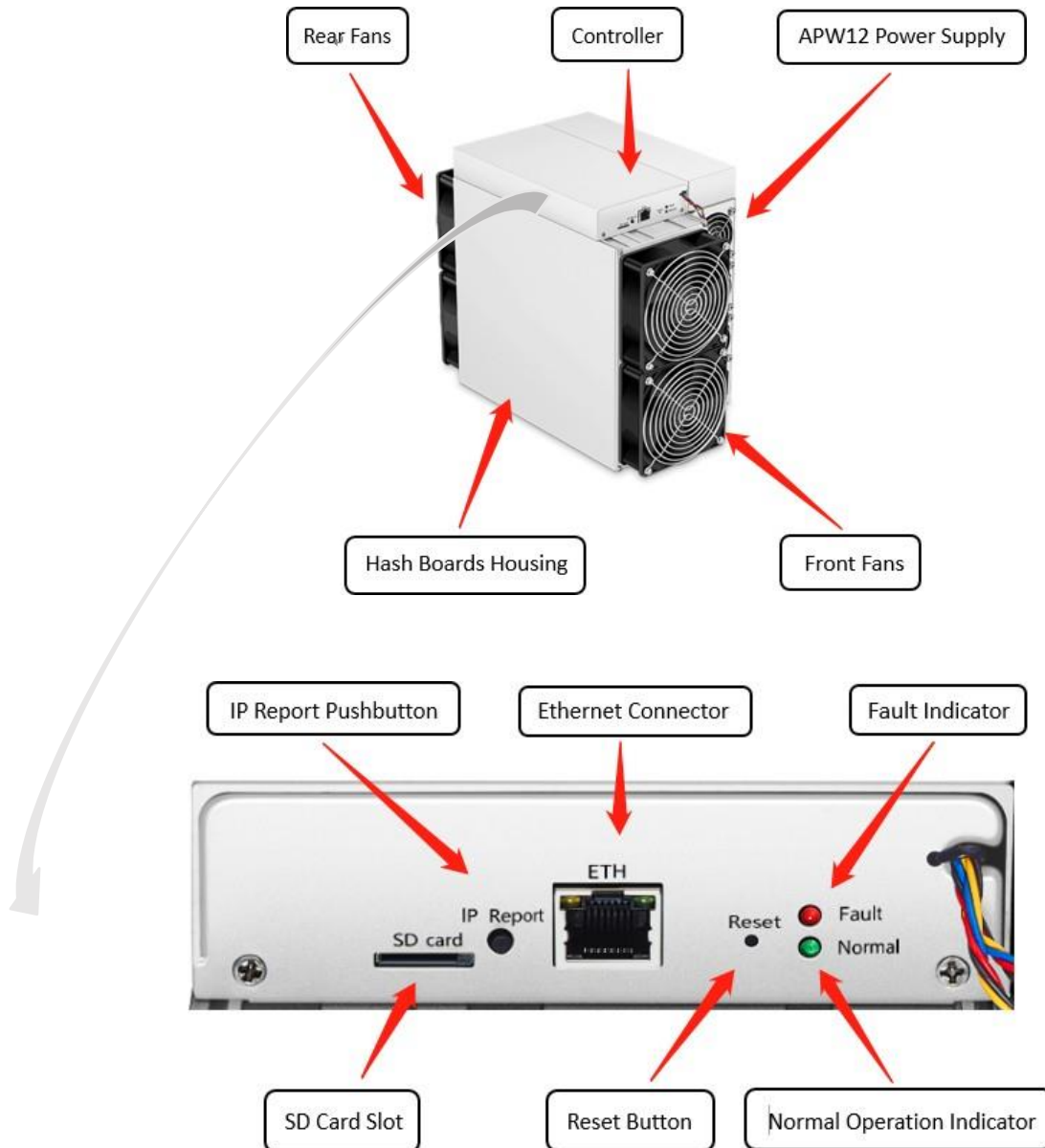

## APW12 Power Supply:



### Note:

1. Power supply APW12 is part of K7 server. For detailed parameters, please refer to the specifications below.
2. Additional two power cords are needed.

## 1.2 Specifications

**Model: K7-63.5T**

**Hashrate: 63.5 TH/s**

Product Glance	Value
Version	240-K
Model	K7-63.5T
Crypto Algorithm/Coins	Eaglesong
Hashrate, TH/s	63.5 ±3%
power on wall@25°C, Watt	3080 ±10%
power efficiency on wall @25°C, J/TH	48.5 ±10%

Detailed Characteristics	Value
<b>Power Supply</b>	
Power supply AC input voltage, Volt <sup>(1-1)</sup>	200~240
Power supply AC Input Frequency Range, Hz	47~63
Power supply AC Input current, Amp <sup>(1-2)</sup>	20 <sup>(1-3)</sup>
<b>Hardware Configuration</b>	
Network connection mode	RJ45 Ethernet 10/100M
Server Size (Length*Width*Height, w/o package), mm <sup>(2-1)</sup>	430*195.5*290
Server Size (Length*Width*Height, with package), mm	570*316*430
Net weight, kg <sup>(2-2)</sup>	16.1
Gross weight, kg	17.7
<b>Environment Requirements</b>	
Operation temperature, °C	0~40
Storage temperature, °C	-20~70
Operation humidity(non-condensing), RH	10~90%
Operation altitude, m <sup>(3-1)</sup>	≤2000

**Model: K7-58T**

**Hashrate: 58 TH/s**

Product Glance	Value
Version	240-K
Model	K7-58T
Crypto Algorithm/Coins	Eaglesong
Hashrate, TH/s	58 ±3%
power on wall@25°C, Watt	2813 ±10%
power efficiency on wall @25°C, J/TH	48.5 ±10%

Detailed Characteristics	Value
<b>Power Supply</b>	
Power supply AC input voltage, Volt <sup>(1-1)</sup>	200~240
Power supply AC Input Frequency Range, Hz	47~63
Power supply AC Input current, Amp <sup>(1-2)</sup>	20 <sup>(1-3)</sup>
<b>Hardware Configuration</b>	
Network connection mode	RJ45 Ethernet 10/100M
Server Size (Length*Width*Height, w/o package), mm <sup>(2-1)</sup>	430*195.5*290
Server Size (Length*Width*Height, with package), mm	570*316*430
Net weight, kg <sup>(2-2)</sup>	16.1
Gross weight, kg	17.7
<b>Environment Requirements</b>	
Operation temperature, °C	0~40
Storage temperature, °C	-20~70
Operation humidity(non-condensing), RH	10~90%
Operation altitude, m <sup>(3-1)</sup>	≤2000



## Notes:

- (1-1) Caution: Wrong input voltage may probably cause Server damaged**
- (1-2) Max condition: temperature 40°C, altitude 0m
- (1-3) Two AC input wires, 10A per wire
- (2-1) Including PSU size
- (2-2) Including PSU weight
- (3-1) When the Server is used at an altitude from 900m to 2000m, the highest operating temperature decreases by 1°C for every increase of 300m

## 2. Setting up the Server

To set up the server:

 The file IPReporter.zip is supported by Microsoft Windows only.

1. Go to the following site: <https://service.bitmain.com/support>
2. Download the following file: IPReporter.zip.
3. Extract the file.

 The default DHCP network protocol distributes IP addresses automatically.

4. Right-click **IPReporter.exe** and run it as Administrator.
5. Select one of the following options:
  - Shelf, Step, Position – suitable for farm servers to mark the location of the servers.
  - Default – suitable for home servers.
6. Click **Start**.

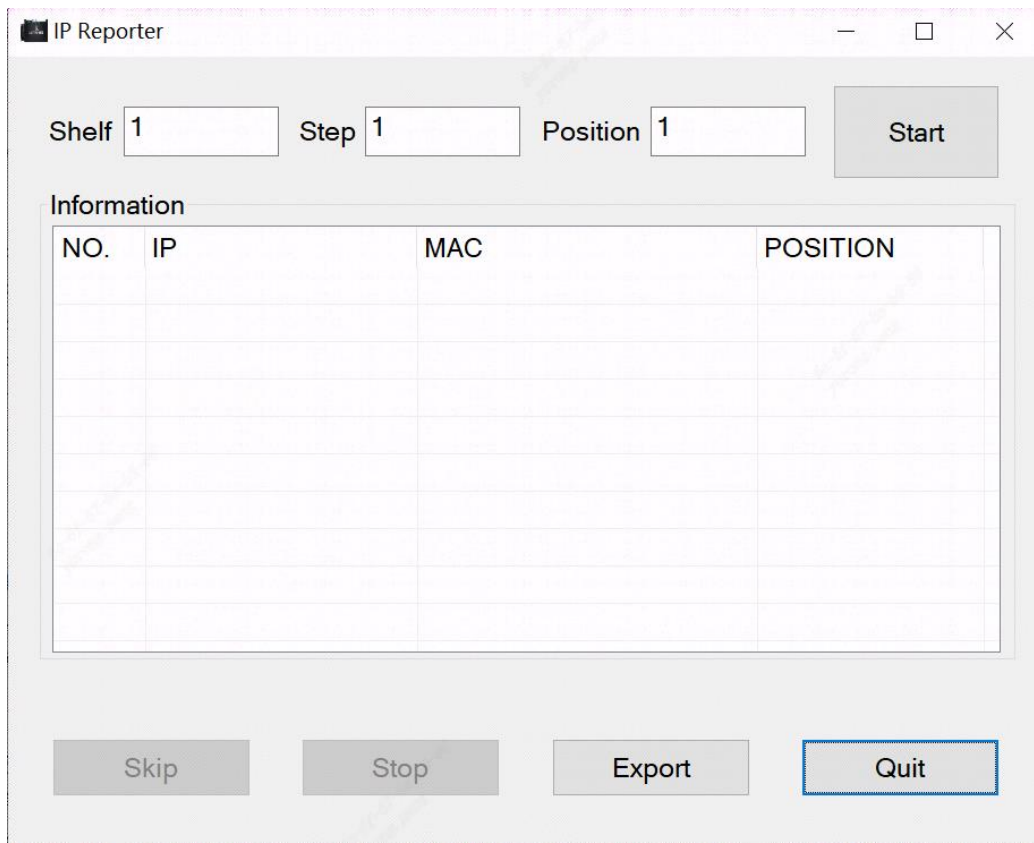

IP Reporter

Shelf  Step  Position

Information

NO.	IP	MAC	POSITION

## 2. Setting up the Server

- On the controller board, click the IP Report button. Hold it down until it beeps (about 5 seconds).

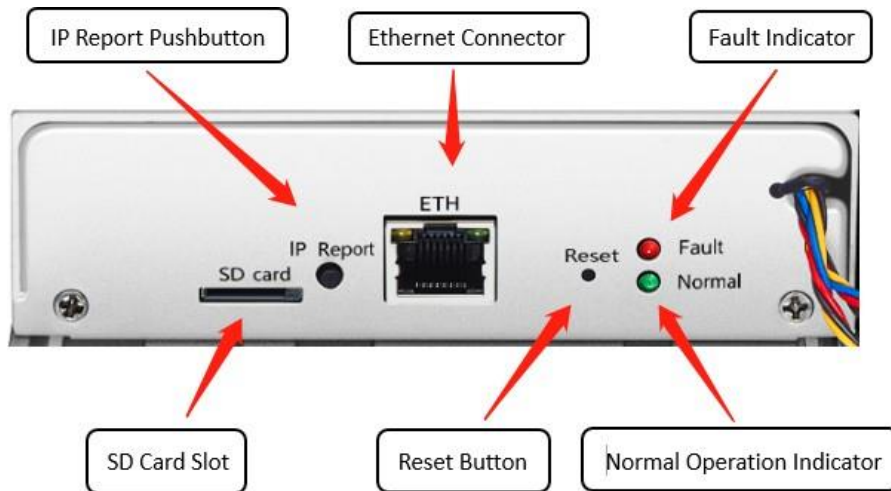

The IP address will be displayed in a window on your computer screen.

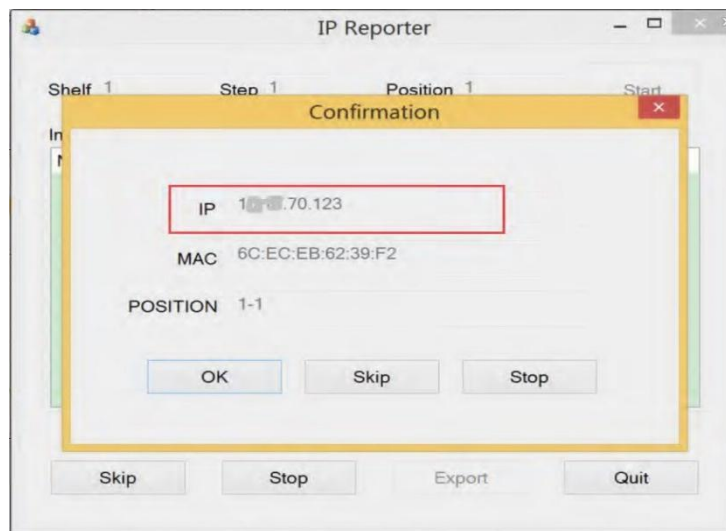

- In your web browser, enter the IP address provided.
- Proceed to login using root for both the username and password.
- In the Protocol section, you can assign a Static IP address (optional).
- Enter the IP address, Subnet mask, gateway and DNS Server.
- Click "Save".
- Click <https://support.BITMAIN.com/hc/en-us/articles/360018950053> to learn more about gateway and DNS Server.

### 2. Setting up the Server

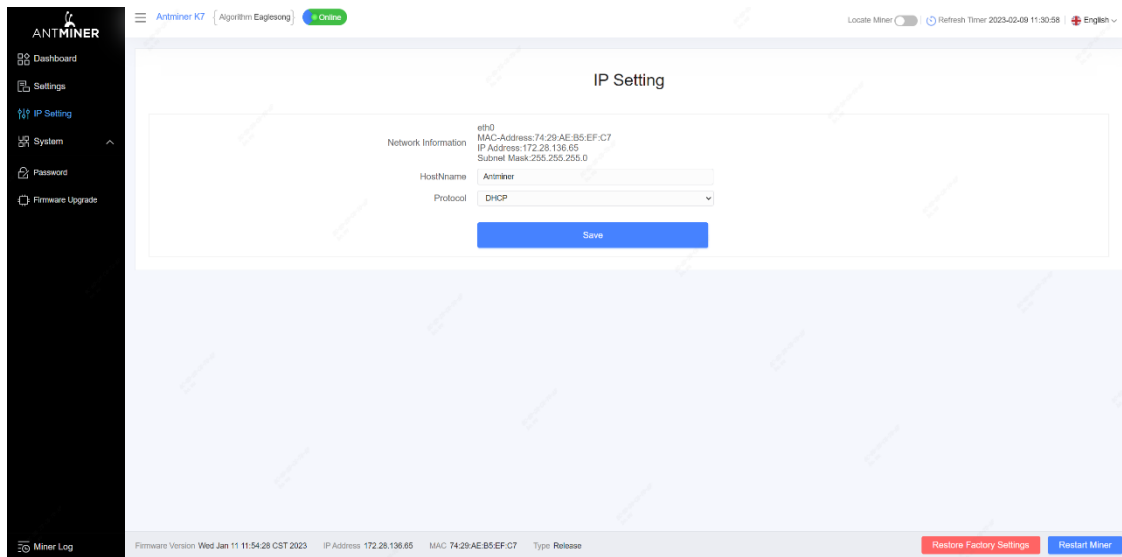

3. Configuring the Server

### 3. Configuring the Server

#### Setting up the Pool

To configure the server:

1. Click **Settings** marked below.

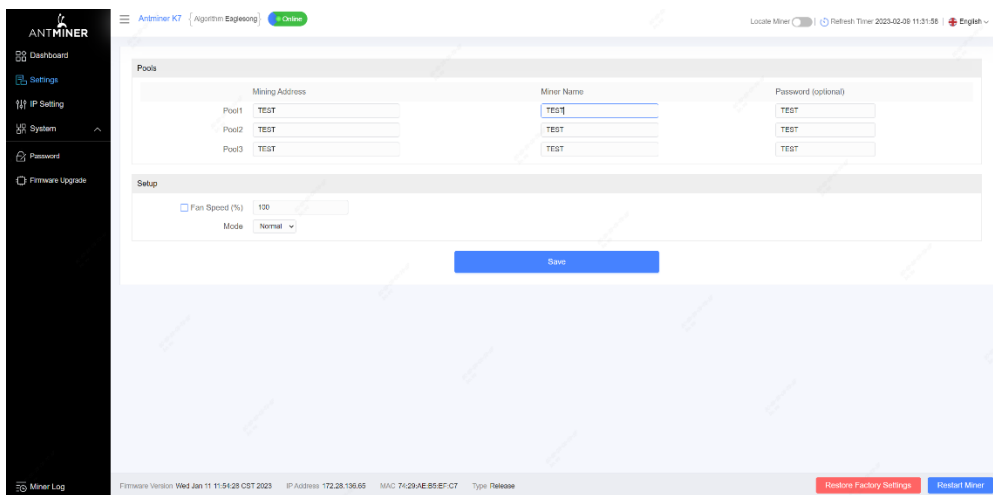

**Note:**

1. Fan speed percentage can be adjusted, but we recommend to keep the default setting. The server will adjust the fan speed automatically if the fan speed percentage has yet been selected.
2. There are two working modes of K7 server: Normal mode and Sleep mode. The server enters the sleep mode under the condition that the control board is powered while hashboards are not powered.

2. Set the options according to the following table:

Option	Description
Mining address	Enter the address of your desired pool.  <div data-bbox="434 1594 1422 1767" style="border: 1px solid black; border-radius: 10px; padding: 10px;">  The K7 servers can be set up with three mining pools, with decreasing priority from the first pool (pool 1) to the third pool (pool 3). The pools with low priority will only be used if all higher priority pools are offline.                 </div>
Name	Your worker ID on the selected pool.
Password (optional)	The password for your selected worker.

3. Click Save after the configuration.

## 4. Monitoring Your Server

To check the operating status of your server:

1. Click dashboard marked below to check the server status (taking K7-63.5T as an example).

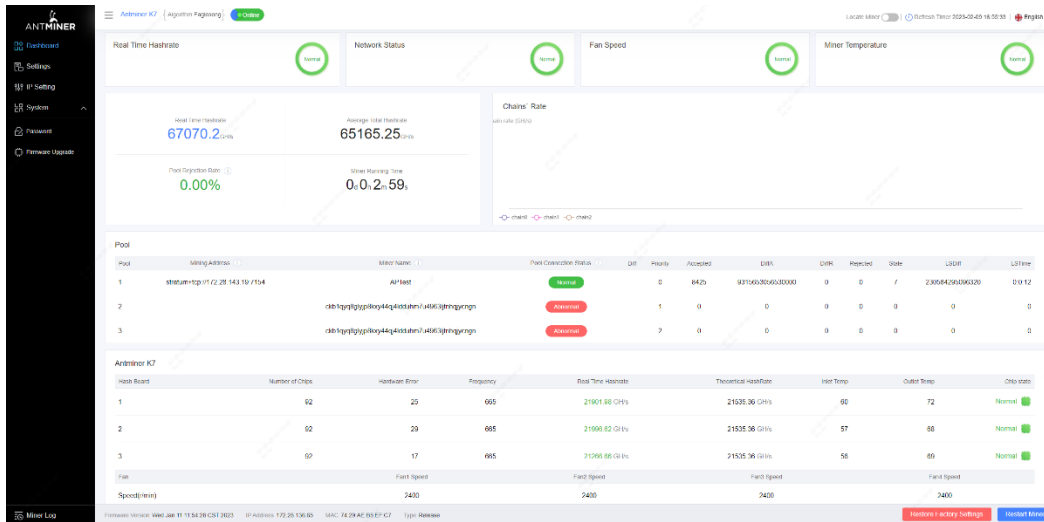

2. Monitor your server according to the descriptions in the following table:



Note: The K7-63.5T server is with fixed frequency 665 MHz. Firmware will stop running when the Temp (Outlet) reaches to 95 °C, there will be an error message “high temp exceed limit (Overtemperature duration/s), max\_chip\_temp = (chip-real-temperature), max\_pcb\_temp = (board-real-temperature)!” shown on the bottom of kernel log page. Meanwhile, the server temperature on the dashboard interface turns to abnormal and shows “Temp is too high”.

Option	Description
Number of chips	Number of chips detected in the chain.
Frequency	ASIC frequency setting.
Real Hashrate	Real-time Hashrate of each hash board (GH/s).
Inlet Temp	Temperature of the inlet (°C).
Outlet Temp	Temperature of the outlet (°C).
Chip state	One of the following statuses will appear: <ul style="list-style-type: none"> <li>● <b>The Green Icon</b> - indicates normal</li> <li>● <b>The Red Icon</b>- indicates abnormal</li> </ul>

## 5. Administering Your Server

### 5.1 Checking Your Firmware Version

To check your firmware version:

1. Enter the backstage of your server, find the firmware version on the bottom.
2. **Firmware Version** displays the date of the firmware your server uses. In the examples below, the server is using firmware version 20230111.

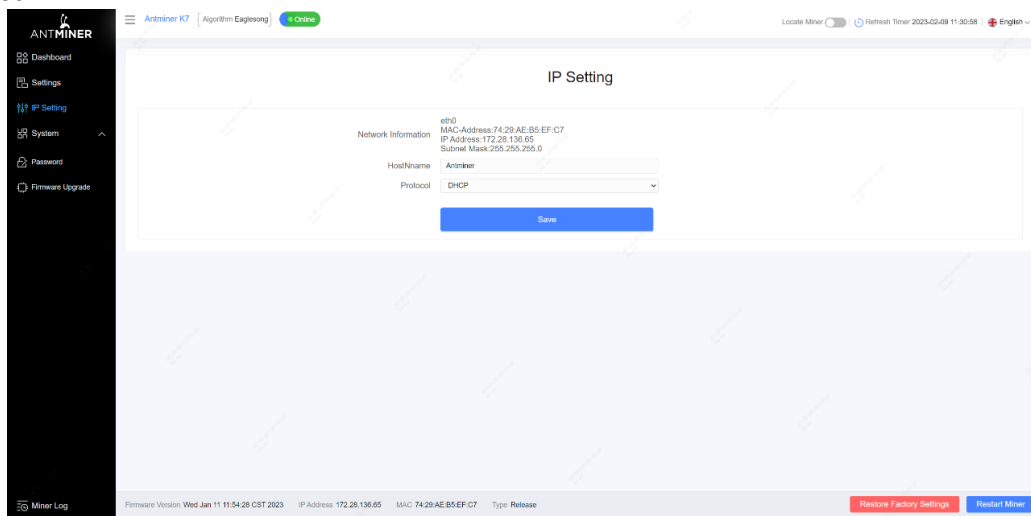

### 5.2 Upgrading Your System



Make sure that the K7 server remains powered during the upgrade process. If power fails before the upgrade is completed, you will need to return it to BITMAIN for repair.

To upgrade the server's firmware:

1. In **System**, click **Firmware Upgrade**.

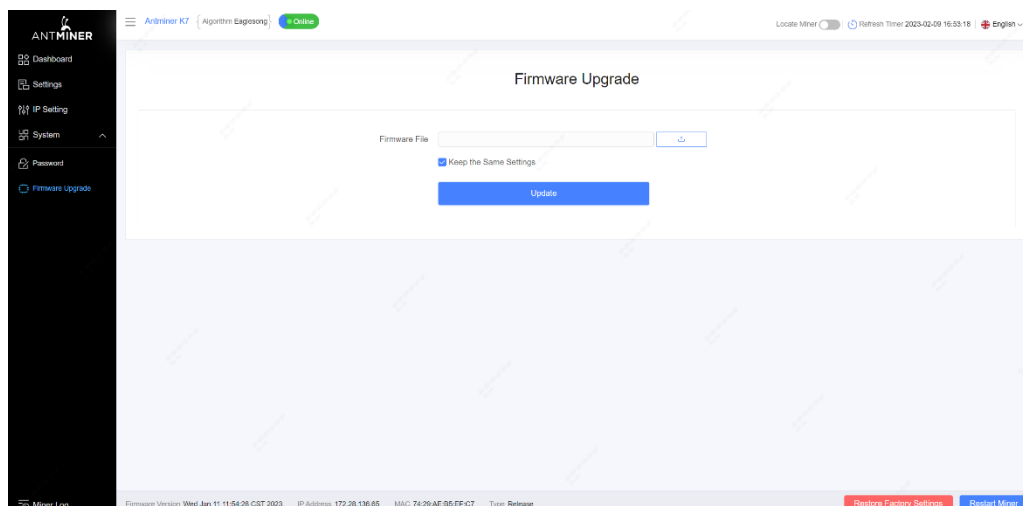

## 5. Administering Your Server

### 2. For **Keep Settings**:

- Select “keep settings” to keep your current settings (default).
- Unselect “keep settings” to reset the server to default settings.

3. Click the  button and navigate to the upgrade file. Select the upgrade file, then click **Update**.

4. When the upgrade is completed, restart the server and it will turn to the setting page.

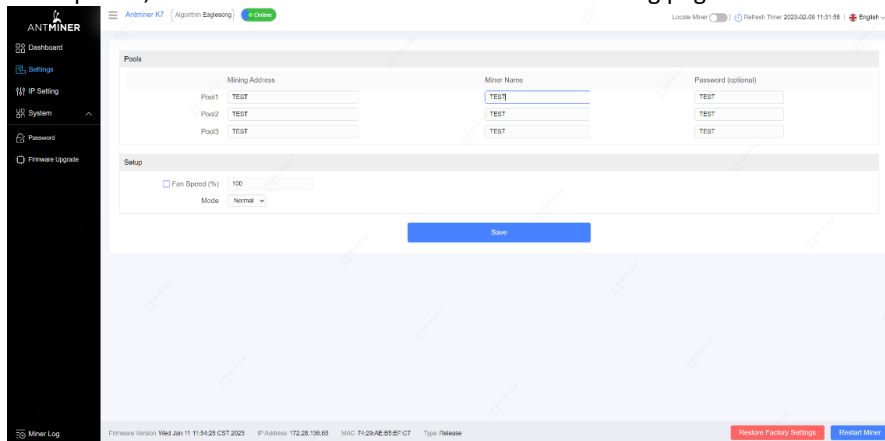

## 5.3 Modifying Your Password

To change your login password:

1. In **System**, click the **Password** tab.
2. Set your new password, then click **Save**.

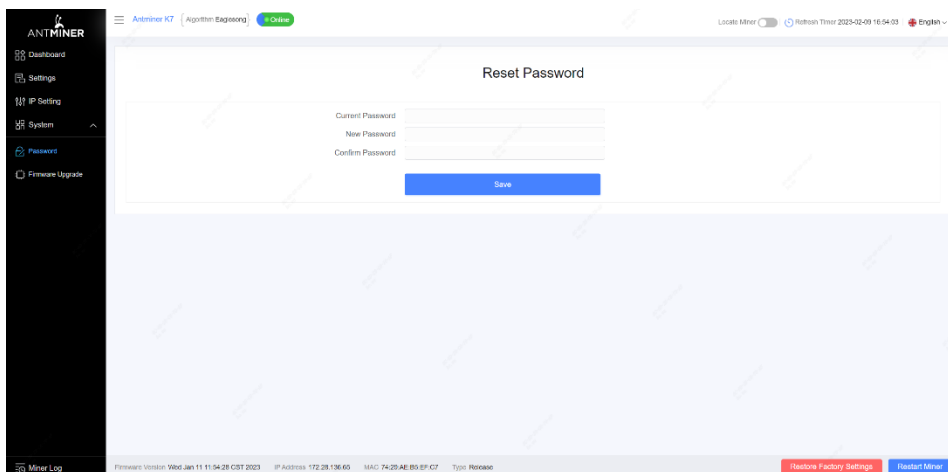

## 5.4 Restoring Initial Settings

To restore your initial settings

1. Turn on the server and let it run for 5 minutes.
2. On the controller front panel, press and hold the **Reset** button for 10 seconds.



Resetting your server will reboot it and restore its default settings. The red LED will automatically flash once every 15 seconds if the reset is operated successfully.



## Environmental Requirements

Please run your server in accordance with the following requirements

### 1. Basic Environmental Requirements:

#### 1.1. Climatic Conditions:

Description	Requirement
Operating Temperature	0-40°C
Operating Humidity	10-90%RH (non-condensing)
Storage Temperature	-20-70°C
Storage Humidity	5-95%RH (non-condensing)
Altitude	<2000m

#### 1.2. Site Requirements of the Server Running Room:

Please keep the server running room away from industrial pollution sources:

For heavy pollution sources such as smelters and coal mines, the distance should be more than 5km.

For moderate pollution sources such as chemical industries, rubber and electroplating industries, the distance should be more than 3.7km.

For light pollution sources such as food factories and leather processing factories, the distance should be more than 2km.

If unavoidable, the site should be chosen in the perennial upwind direction of the pollution source.

Please do not set your location within 3.7km from the seaside or the salt lake. If unavoidable, it should be built as airtight as possible, equipped with air conditioning for cooling.

#### 1.3. Electromagnetic Environmental Conditions:

Please keep your site away from transformers, high-voltage cables, transmission lines and high-current equipment, for example, there should be no high-power AC transformers (>10KA) within 20 meters, and no high-voltage power lines within 50 meters.

Please keep your site away from high-power radio transmitters, for example, there should be no high-power radio transmitters (>1500W) within 100 meters.

### 2. Other Environmental Requirements :

The server running room shall be free of explosive, conductive, magnetically conductive and corrosive dust. The requirements of mechanical active substances are shown below:

#### 2.1 Requirements of Mechanical Active Substances

Mechanical Active Substance	Requirement
Sand	$\leq 30\text{mg}/\text{m}^3$
Dust (suspended)	$\leq 0.2\text{mg}/\text{m}^3$
Dust (deposited)	$\leq 1.5\text{mg}/\text{m}^2\text{h}$

## 2.2 Requirements of Corrosive Gas

Corrosive Gas	Unit	Concentration
H <sub>2</sub> S	ppb	< 3
SO <sub>2</sub>	ppb	< 10
Cl <sub>2</sub>	ppb	< 1
NO <sub>2</sub>	ppb	< 50
HF	ppb	< 1
NH <sub>3</sub>	ppb	< 500
O <sub>3</sub>	ppb	< 2

Note: ppb (part per billion) refers to the unit of concentration, 1ppb stands for the volume ratio of part per billion.

## Regulations:

### FCC Notice (FOR FCC CERTIFIED MODELS):

This device complies with part 15 of the FCC Rules. Operation is subject to the following two conditions: (1) This device may not cause harmful interference, and (2) this device must accept any interference received, including interference that may cause undesired operation.

### Note:

This equipment has been tested and found to comply with the limits for a Class A digital device, pursuant to part 15 of the FCC Rules. These limits are designed to provide reasonable protection against harmful interference when the equipment is operated in a commercial environment. This equipment generates, uses, and can radiate radio frequency energy and, if not installed and used in accordance with the instruction manual, may cause harmful interference to radio communications. Operation of this equipment in a residential area is likely to cause harmful interference in which case the user will be required to correct the interference at his own expense.

### EU WEEE: Disposal of Waste Equipment by Users in Private Household in the European Union



This symbol on the product or on its packaging indicates that this product must not be disposed of with your other household waste. Instead, it is your responsibility to dispose of your waste equipment by handing it over to a designated collection point for the recycling of waste electrical and electronic equipment. The separate collection and recycling of your waste equipment at the time of disposal will help to conserve natural resources and ensure that it is recycled in a manner that protects human health and the environment. For more information about where you can drop off your waste equipment for recycling, please contact your local city office, your household waste disposal service or the shop where you purchased the product.

### 台灣 ROHS:

設備名稱: K7

單元	有害物質					
	鉛 (Pb)	汞 (Hg)	鎘 (Cd)	六價鉻 (Cr+6)	多溴聯苯 (PBB)	多溴二苯醚 (PBDE)
外殼	○	○	○	○	○	○
電路板組件	—	○	○	○	○	○
其他線材	—	○	○	○	○	○

備考 1. “超出 0.1 wt %” 及 “超出 0.01 wt %” 係指限用物質之百分比含量超出百分比含量基準值。  
 備考 2. “○” 係指該項限用物質之百分比含量未超出百分比含量基準值。  
 備考 3. “—” 係指該項限用物質為排除項目。